

Data Sheet



Article number: 021816025289

Description: Clamp with bracket and rubber
SPGU 6025. 289/30 SK

Measures

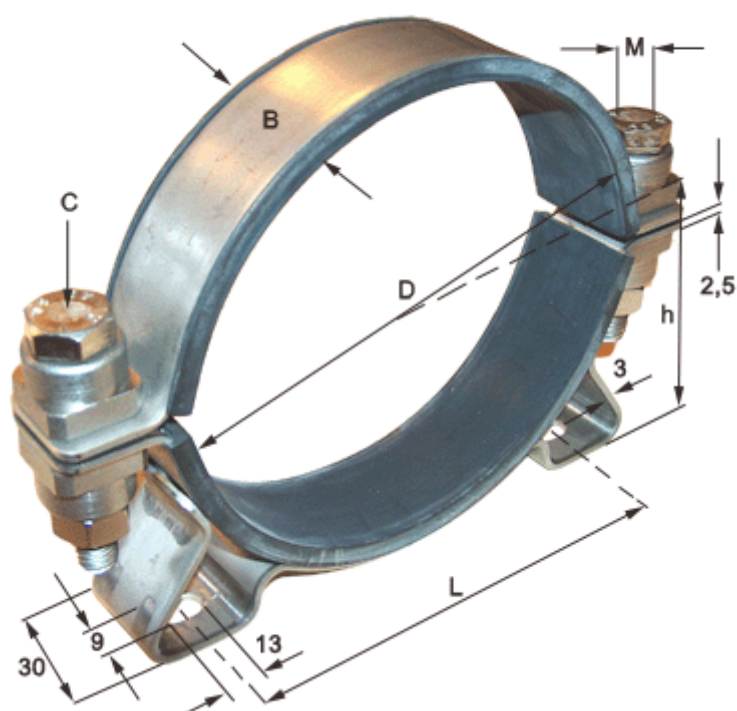

C (screw type) = SK hexagon screw

Diameter D = 289

h = 153

L = 280

Width B = 30